

HOME EDITION



/24

PREVIEW

Frigerio

HOME EDITION

/24

PREVIEW

Frigerio



VIEW SOFA
05



EDDIE / EDDIE DOUBLE SOFA
33



AMANDA SMALL SOFA
55



MAYU ARMCHAIR
61



ADA ARMCHAIR
65



HELIX POUF
119



ELLY TABLE
71



HUG CHAIR/ARMCHAIR/STOOL
81



UNIQUE BOOKCASE
109



ELLY SMALL TABLE
87



ANDOREA SMALL TABLE
93



EDDIE SMALL TABLE
99



HULI BENCH / STOOL
115



MOCKY SMALL TABLE / CONSOLE
103

Perfetta sinergia fra innovazione e tradizione
che si esprime in una collezione dal gusto contemporaneo
e dall'animo internazionale.

*Perfect synergy between innovation and tradition,
which expresses itself into a contemporary collection
with an international spirit.*

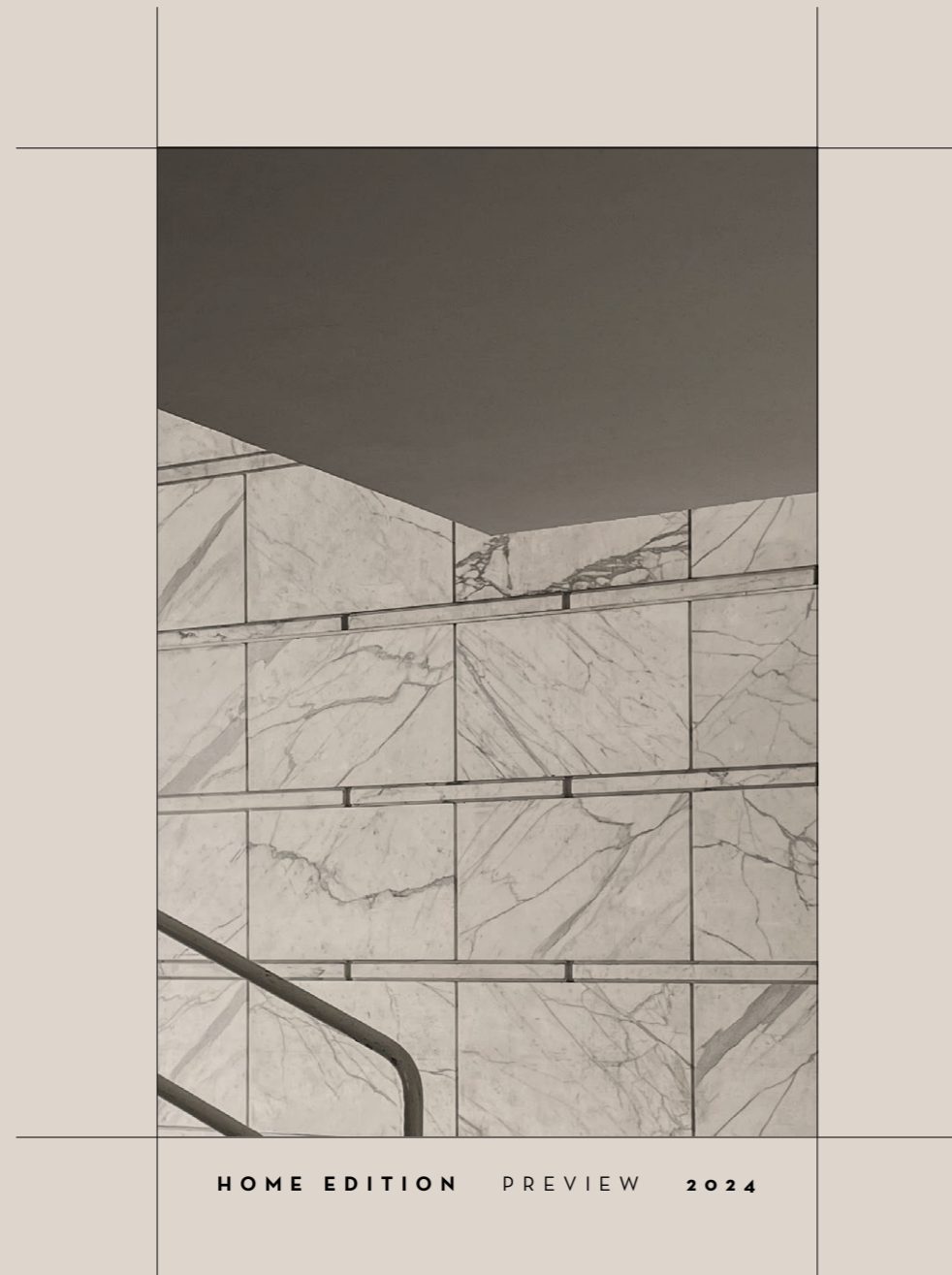

HOME EDITION PREVIEW 2024

VIEW

Ferruccio Laviani

View è un divano modulare con inediti elementi compositivi disponibile con base a terra imbottita e su piattaforma in legno o laccata lucido per l'area living; sintesi perfetta dell'estro creativo di Ferruccio Laviani e il know-how dell'azienda.

View is a modular sofa with unexpected sectional elements available with padded base on floor or on wooden or glossy lacquered platform for the living area; perfect synthesis between the creative flair of Ferruccio Laviani and the company's know-how.



La piattaforma in legno del divano View, disponibile anche in colori laccati lucidi, dona una vibrazione contemporanea per un elemento architettonico audace.

View sofa's wooden platform, available also in glossy lacquered colours, provides a contemporary vibe for a bold architectural feature.





A E S T H E T I C S A N D F U N C T I O N



VIEW PLATFORM sofa / HULI armchair & bench / ELLY small table



La collezione offre un'ampia gamma di tavolini integrati per soluzioni modulari inaspettate per un design moderno e conviviale.

The collection offers a wide range of small tables for unexpected modular solutions for a modern and convivial design.



L I G H T A N D E S S E N T I A L D E S I G N



VIEW | FERRUCCIO LAVIANI



VIEW PLATFORM sofa & pouf & small table/ ADA armchair

Elegante e contemporaneo, il divano View si caratterizza da volumi proporzionati e finemente bilanciati e da accessori, come la libreria retro-divano, per un arredo funzionale.

Elegant and contemporary, the sofa View features finely proportioned volumes and accessories, such as the bookcase to be placed at the back of the sofa, for a functional furnishing.



Colori significativi e forme bilanciate: il divano modulare View offre un'ampia gamma di soluzioni arredative con opzioni ricche di colori che offrono un'ulteriore libertà creativa.

Meaningful colours and balanced shapes: the sectional sofa View offers a wide range of planning solution with colourful options providing an additional creativity freedom.





La piattaforma del divano View è disponibile con inserti in marmo per un risultato ancora più lussuoso e la lavorazione del piedino esalta le capacità artigianali della produzione aziendale nella cura di ogni dettaglio.

The platform of the sofa View is available with marble insert to achieve a luxury finish and the workmanship of the sofa's feet enhances the artisan company's care of every single detail.

VIEW | FERRUCCIO LAVIANI



VIEW PLATFORM & SOFT sofa / VIEW small table / HULI armchair / ELLY server



Il divano View offre un'ampia gamma di elementi modulari, come la comoda chaise longue e forme non convenzionali su piattaforma con opzioni ricche di colore e un aggiuntivo schienale free-standing.

View sofa offers a wide range of modular elements, such as comfortable chaise longue and unconventional shapes for the platform with colourful options and additional free-standing backrest.



VIEW PLATFORM & SOFT sofa & pouf / ELLY server / SANTAMONICA small table

FLAWLESS GEOMETRICAL PASSION



VIEW PLATFORM & SOFT sofa & pouf / ELLY server / SANTAMONICA small table

VIEW SOFT sofa / VIEW PLATFORM pouf & small table / UNIQUE bookcase / JACKIE armchair / ELLY server / TAMU mirror



Il divano View offre composizioni esteticamente piacevoli dal gusto più classico grazie agli elementi imbottiti a terra con il profilo decorativo in contrasto.

View sofa offers aesthetically pleasing layouts for more classical planning solutions with all elements padded on floor with the decorative piping in contrast.



pag. 6/7

VIEW SOFA

HULI armchair
17900+17901 cm 76x84x89h

HULI bench
17904 cm 120x40x42h

ELLY small table
18281 cm 160x100x28h

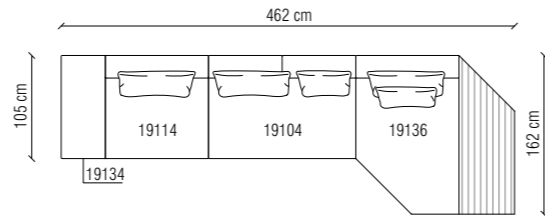

pag. 18/19

VIEW SOFA

HULI armchair
17900 cm 76x84x89h

ELLY server
18282 cm 39x40x41h
18283 cm 39x40x49h

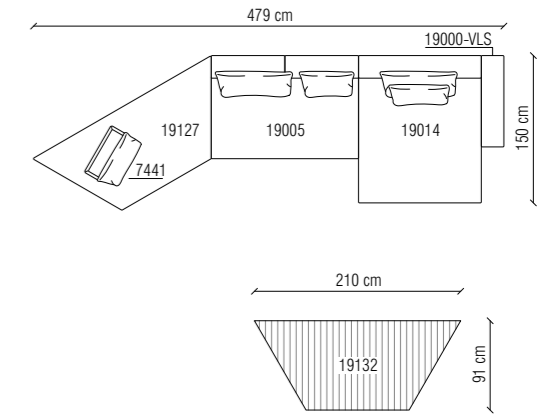

pag. 12/13

VIEW SOFA

ADA armchair
20600 cm 86x99x87h

ELLY server
18283 cm 39x40x49h

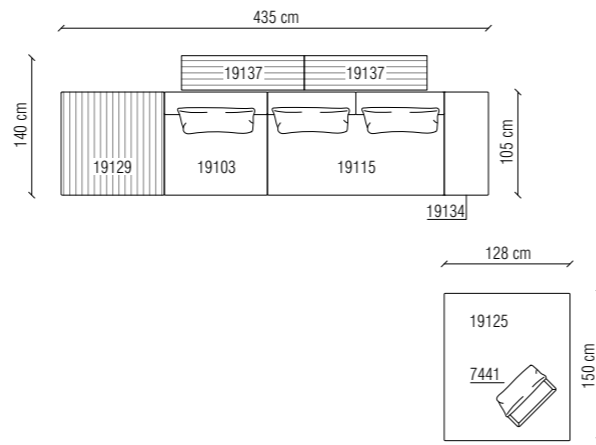

pag. 20/21

VIEW SOFA

ELLY server
18283 cm 39x40x49h

SANTAMONICA small table
18105 Ø cm 121/123x27h

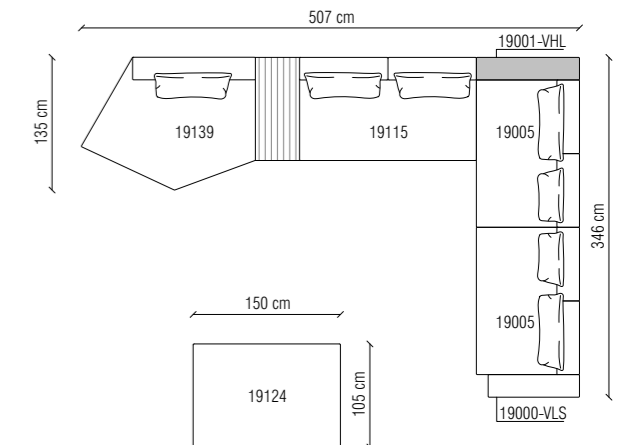

pag. 14/15

VIEW SOFA

ELLY small table
18281 cm 160x100x28h

ELLY server
18283 cm 39x40x49h

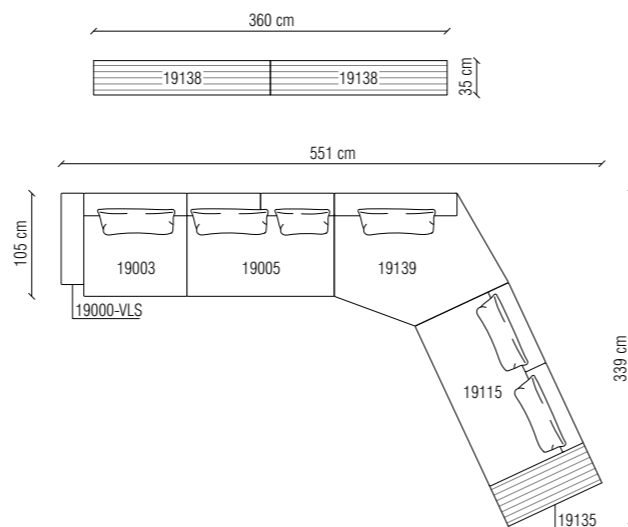

pag. 24/25

VIEW SOFA

JACKIE armchair
11504 cm 75x83x72h

ELLY server
18283 cm 39x40x49h

UNIQUE bookcase
20703 cm 120x44x183h

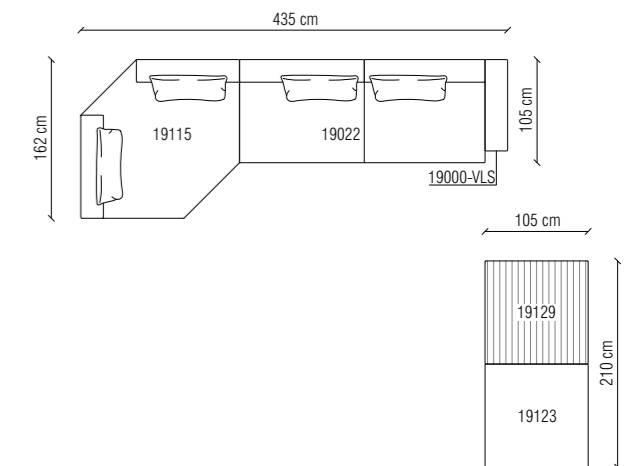

VIEW COLLECTION

View è una collezione di divani modulari disponibile sia nella versione View Soft che nella versione View Platform, fra di loro utilizzabili in combinazione.

View is a collection of modular sofa available in the View Soft version and in the View Platform version, which can be combined to each other.

VIEW SOFT

View Soft è una collezione di elementi centrali con struttura imbottita a terra a cui possono essere aggiunti elementi braccioli o schienali.

View Soft is a collection of central element with padded base on floor to which armrests or backrests can be added.



VIEW PLATFORM

View Platform è una collezione di divani ed elementi componibili con struttura costituita da una piattaforma in legno e da una versione classica del bracciolo.

View Platform is a collection of sofas and elements for compositions with a wooden platform as structure, and with a classic armrest version.



VIEW PLATFORM TOP

View Platform Top presenta gli elementi caratterizzati dalla piattaforma in legno che sporgono dagli stessi creando un top utilizzabile per l'appoggio di accessori.

View Platform Top features the wooden platform that extends from them, creating a top that can be used to support accessories.



VIEW COLLECTION

Serie di braccioli, schienali e accessori componibili con la collezione.

Series of armrests, backrests and accessories that can be combined with the collection.

BRACCIOLO VIEW SOFT / ARMREST VIEW SOFT



SCHIENALE VIEW SOFT 105 PER COMPOSIZIONE ANGOLARE / BACKREST VIEW SOFT 105 FOR CORNER COMPOSITION



BRACCIOLO VIEW PLATFORM / ARMREST VIEW PLATFORM



VOLUME SOFT



BOOKCASE



TOP 45 CM



TOP 75 CM



VIEW COMPOSITIONS



COMPOSIZIONE / COMPOSITION 1



COMPOSIZIONE / COMPOSITION 2



COMPOSIZIONE / COMPOSITION 3

Il divano View è disponibile in due versioni: Platform, con una piattaforma in legno o nei colori laccati lucidi della collezione, o Soft, con base imbottita a terra per soluzioni più tradizionali. Le basi sono fra di loro combinabili.

The View sofa is available in two versions: Platform, with a wooden platform or in glossy lacquered colors from the collection, or Soft, with a padded base on the floor for more traditional solutions. The bases can be used with each other.

VIEW SOFA

Ferruccio Laviani

Collezione di divani componibili con differenti basi combinabili fra di loro, disponibile in versione platform su piattaforma in legno o laccata lucido o in versione soft su base imbottita a terra, coordinati con differenti tipologie di braccioli. Completano la gamma volumi imbottiti integrati, tavolini e librerie retro-divano.

Collection of sectional sofas with different bases combined with each other, available in platform version with wooden or glossy lacquered platform or soft version on padded base on floor, coordinated with different types of armrests. The collection is completed by padded volumes, small tables and back-placement bookcases.

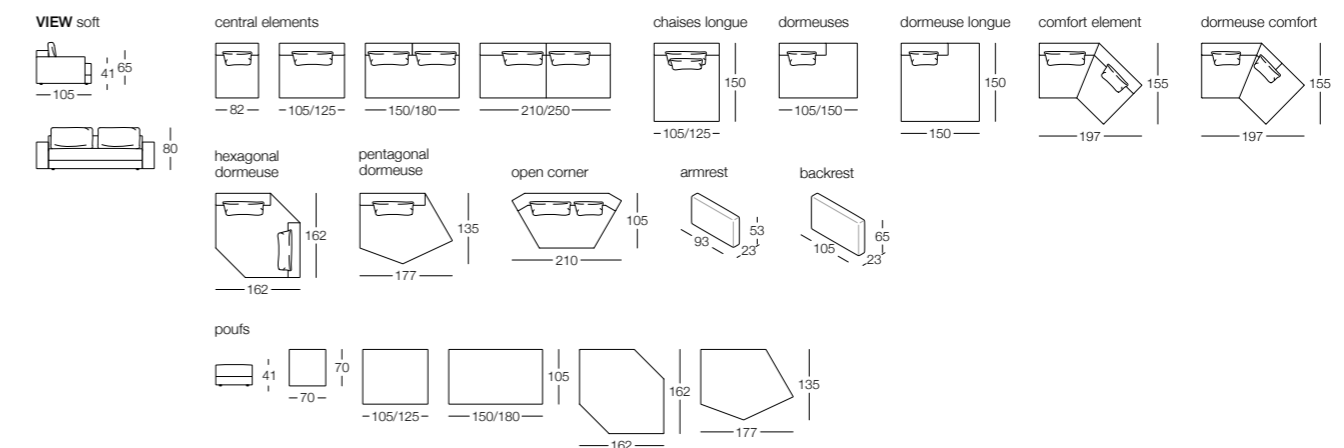
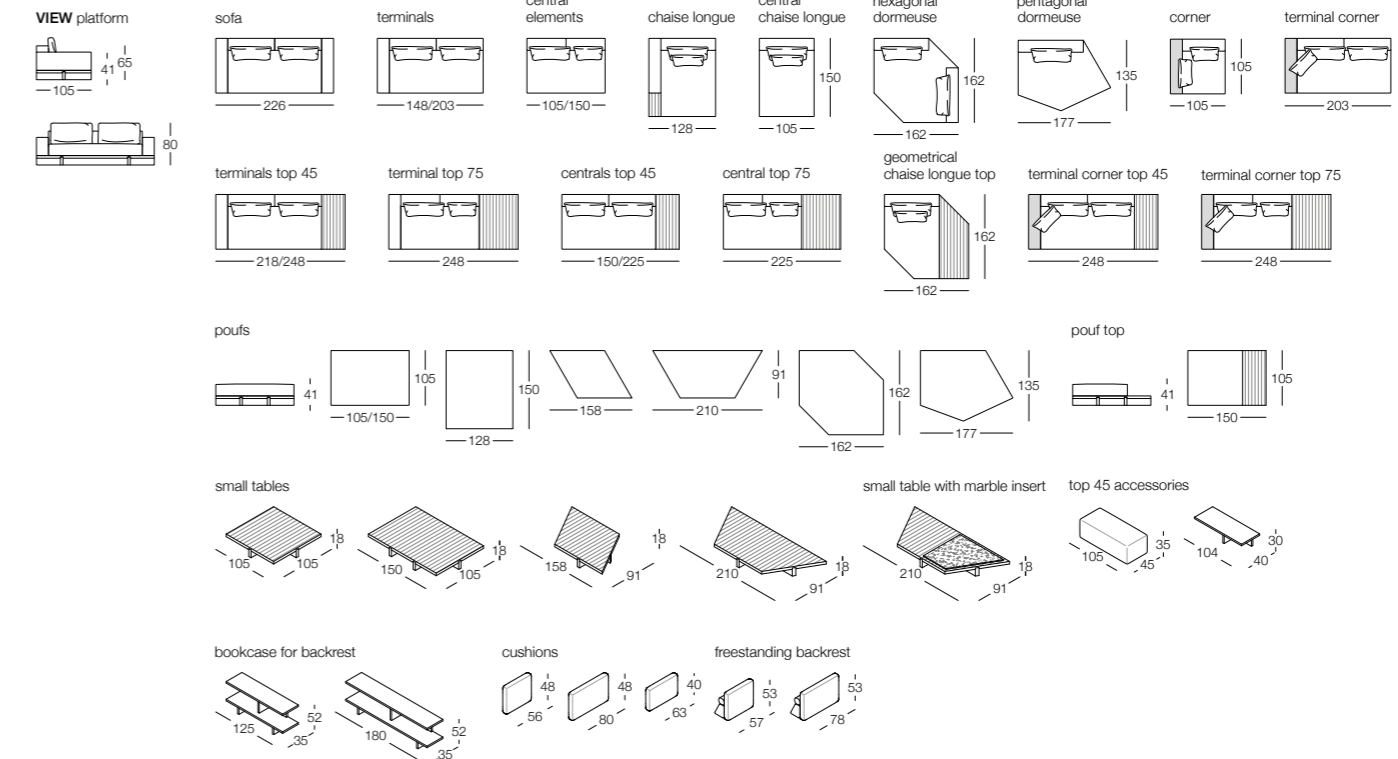

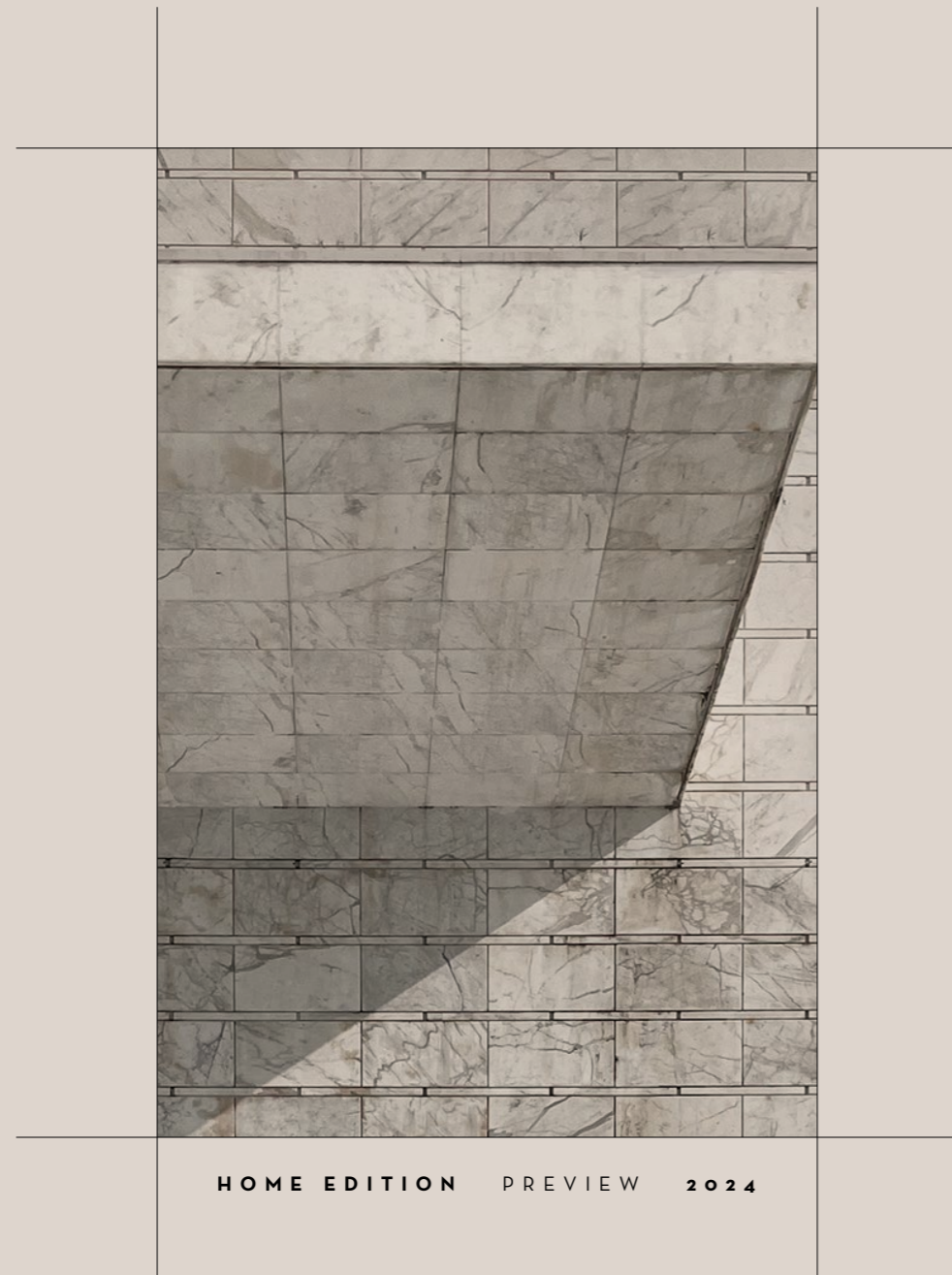

HOME EDITION PREVIEW 2024

EDDIE

R&D Frigerio

Eddie è una collezione di divani modulari a terra con basamento in legno rivestito in pelle o tessuto. Dal gusto contemporaneo ed elegante, il divano Eddie è disponibile sia in soluzioni lineari classiche che in inaspettate soluzioni bifacciali per risultati scenografici.

Eddie is a collection of modular sofas with wooden base on floor covered in leather or fabric. With a contemporary and elegant style, the sofa Eddie is available in more classical linear solutions and also in unexpected double-sided compositions for more scenographical results.



Una soluzione lineare con un twist moderno grazie al tavolino integrato in laccato lucido. Gli elementi del divano Eddie sono liberamente combinabili per creare soluzioni completamente personalizzabili.

A classical linear solution with a modern twist thanks to the integrated small table in glossy lacquered colours. Eddie sofa's elements can be freely matched to create a personalized composition for every environment.



EDDIE sofa & pouf & small table / **ARIANNA** armchair / **SANTAMONICA** small table / **ELLY** server



Il basamento del divano Eddie diventa elemento caratterizzante e distintivo che prosegue nel dettaglio dei tavolini integrati per creare un disegno di continuità e di leggerezza.

The base of the Eddie sofa becomes a featuring element and a hallmark continuing in the detail of the integrated small table to create a design of unbroken lines and lightness.



PURE AND INNATE DESIGN



EDDIE | R&D FRIGERIO



Semplicità ad un altro livello, dove la cura e l'attenzione per i dettagli diventano l'essenza del divano Eddie: la seduta con trapuntata orizzontale e il profilo in contrasto delineano un design dalla forza innata.

Simplicity to the next level, where the care and the attention to the details become the essence of the Eddie sofa: horizontal quilted seat and piping in contrast outline a design with innate strength.

Eddie è un divano dalle linee essenziali che si inserisce facilmente in diversi ambienti domestici evidenziando il classico dettaglio della base e la cura nei particolari.

Eddie is a sofa with essential lines, which fits easily into different home environments highlighting the classic detail of the base and the attention to detail.





EDDIE DOUBLE sofa / **EDDIE** small table / **ELLY** server



Il divano Eddie si caratterizza dalla possibilità di avere una raffinata trapuntatura orizzontale sui cuscini di seduta, dal dettaglio minuzioso della curva del divano che si specchia nella curva del tavolino integrato e dalle infinite combinazioni possibili grazie alla versione bifacciale.

Eddie sofa features the possibility to have a refined horizontal quilting on the seat cushions, the meticulous detail of the curve of the sofa mirrored in the curve of the integrated small table and the endless possible combinations thanks to the double-sided version.



H A R M O N Y T A K E S S H A P E



EDDIE DOUBLE | R&D FRIGERIO



EDDIE DOUBLE sofa & pouf / **AMANDA** armchair & chair with armrests / **ELLY** server / **SANTAMONICA** small table / **TAMU** mirror



pag. 34/35

EDDIE SOFA

ARIANNA armchair
17902 cm 83x81x79h

ELLY server
18283 cm 39x40x49h

SANTAMONICA small table
18101 Ø cm 59/61x39h

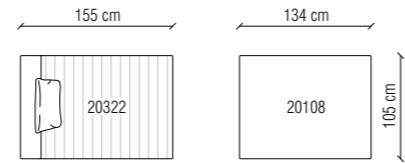
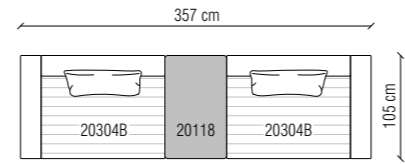

pag. 42/43

EDDIE SOFA

ELLY server
18283 cm 39x40x49h

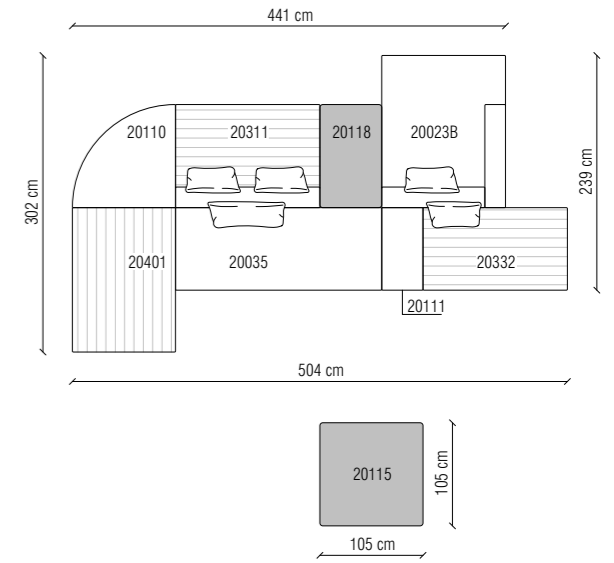

pag. 38/39

EDDIE SOFA

ADA armchair
20600 cm 86x99x87h

KEVIN small table
16607 Ø cm 45/47x50/60h

KEVIN console
16624G cm 160x34x72/82h

KEVIN mirror
16627 Ø cm 180x18x182h

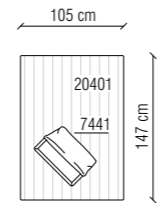
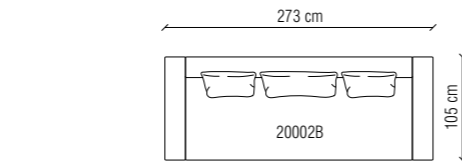

pag. 46/47

EDDIE SOFA

AMANDA armchair
17912 cm 71x85x75h

ELLY server
18283 cm 39x40x49h

SANTAMONICA small table
18100 Ø cm 59/61x50h

AMANDA chair with armrests
17911 cm 53x57x79h

ELLY table
18276 cm 240x130x74h

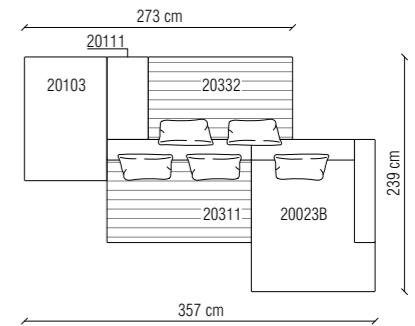

pag. 40/41

EDDIE SOFA

MAYU armchair
17940 cm 98x85x121h

KEVIN pouf
16605 Ø cm 65/67x40h

KEVIN console
16624G cm 160x34x72/82h

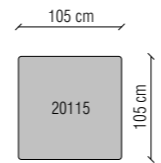
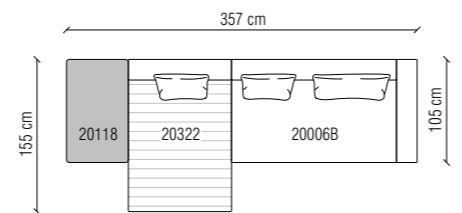

EDDIE BRACCIOLI / ARMRESTS

Eddie propone differenti tipologie di braccioli.

Eddie sofa offers different type of armrests.



BRACCIOLO BASSO / LOW ARMREST



BRACCIOLO ALTO / HIGH ARMREST

EDDIE ACCESSORI / ACCESSORIES

Eddie propone una collezione di accessori per ampliare l'offerta compositiva.

Eddie offers a collection of accessories to give a wider planning offer.



VOLUME / VOLUME

Volumi imbottiti disponibili in differenti dimensioni.
Padded volumes available in different sizes.



EDDIE DOUBLE

Eddie Double si caratterizza da elementi di "seduta" consentendo la realizzazione di composizioni bifacciali.

Eddie Double features "seat" elements to create double-sided compositions.



TAVOLINO / SMALL TABLE

Collezione di tavolini in differenti misure da accostare a composizioni modulari o da utilizzare come elementi free-standing.

Collection of small tables in different size to be used with modular composition or to be used as free-standing elements.



EDDIE COMPOSITIONS



COMPOSIZIONE / COMPOSITION 1



COMPOSIZIONE / COMPOSITION 2



COMPOSIZIONE / COMPOSITION 3

Il divano Eddie è disponibile con la seduta cuscino liscia o con una trapunta orizzontale e con tavolini integrati che possono essere anche utilizzati per un libero posizionamento.

The Eddie sofa is available with plain seat cushion or with horizontal quilting and with integrated small tables, which could be also used for free placement.

EDDIE SOFA

R&D Frigerio

Collezione di divani componibili anche nella versione bifacciale, con basamento rivestito in pelle o tessuto e con la possibilità di avere i cuscini di seduta lisci (plain) o con una trapunta orizzontale (quilted). Disponibili due altezze di braccioli. Completano la collezione un'ampia gamma di tavolini integrati o per libero posizionamento.

Collection of sectional sofa, also available in the double-sided version, with base covered in leather or fabric and with the possibility to have the cover with the seat cushion either plain or with horizontal quilting. Available also with two different armrests' heights. The collection is completed by integrated small table, which can be also used as free-standing elements.



EDDIE

low armrest

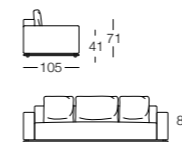

sofas

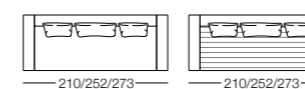

terminals

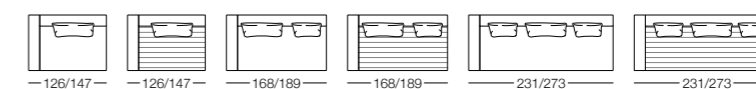

dormeuses



terminal comfort



chaises longue

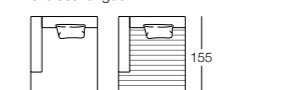

high armrest

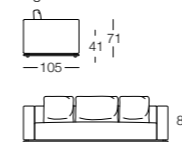

sofas

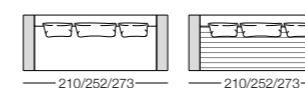

terminals



dormeuses

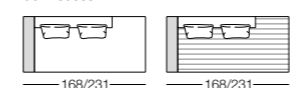

terminal comfort



chaises longue

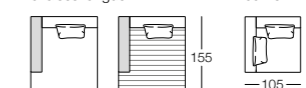

corner

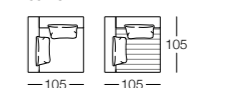

without armrest

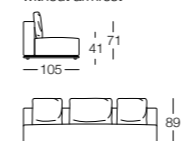

central elements

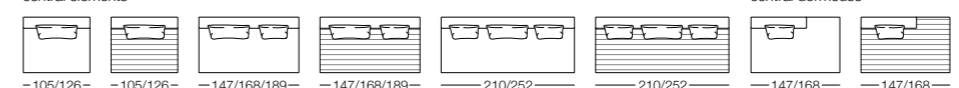

central dormeuse

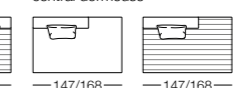

central comfort elements



central dormeuses comfort



central chaises longue

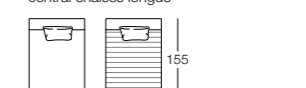

poufs

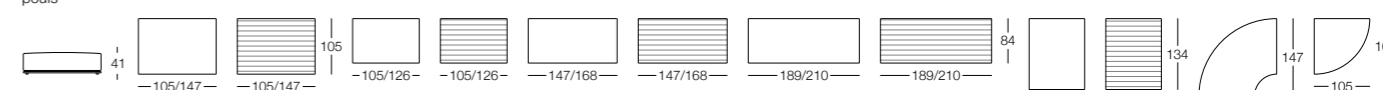

volumes

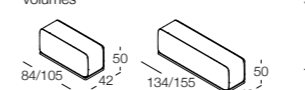

small tables

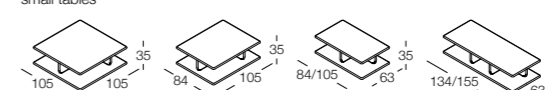

cushions

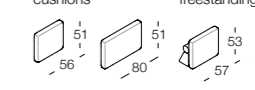

freestanding backrest

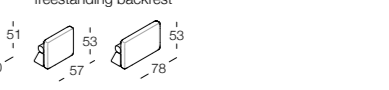

EDDIE seat elements

low armrest

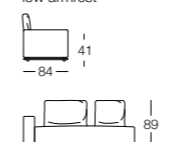

seat terminals

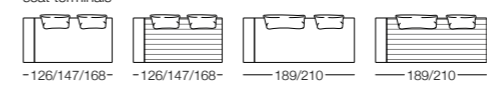

seat chaises longue



seat central elements

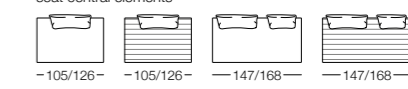

high armrest



seat terminals

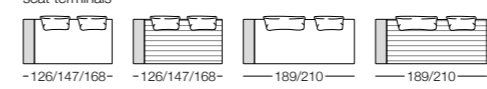

seat chaises longue



seat central chaises longue

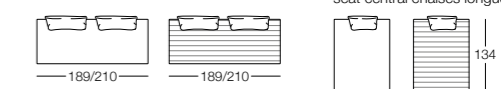



HOME EDITION PREVIEW 2024

AMANDA

Umberto Asnago

Il divanetto Amanda nasce dall'idea concettuale dell'omonima collezione a cui si ispira e ne eredita il design della struttura dai braccioli avvolgenti con calibrate proporzioni tra seduta e schienale. Il basamento è disponibile in frassino nei colori a catalogo Frigerio e il rivestimento può essere in pelle o tessuto, oppure nella versione bimatetica, con la parte esterna dello schienale rivestita in pelle.

The Amanda small sofa is conceived from the conceptual idea of the collection having the same name, from which it is inspired and inherits the design of the structure with its enveloping armrests with balanced proportions between seat and back. The base is made of ashwood in the colours of Frigerio range and the cover is either in leather or fabric, or also available in a two-material version, with the outer part of the back covered in leather.



ELEGANT AND LASTING SILHOUETTE



AMANDA SMALL SOFA

Umberto Asnago

Divanetto due posti in tessuto o pelle o nella versione con parte esterna rivestita in pelle e internamente in tessuto.

Base in legno. La collezione si completa da una poltrona, una bergere, un pouf, una sedia e una sedia con braccioli.

Two-seater sofa in fabric or leather or in the version with the external part in leather and internal part in fabric.

Base in wood. The collection is completed by an armchair, a bergere, a pouf, a chair and a chair with armrests.

SMALL SOFA

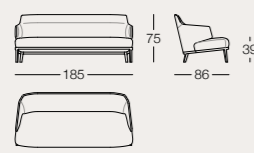

ARMCHAIR

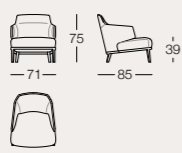

BERGÈRE

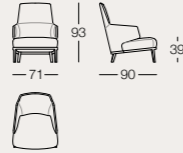

POUF

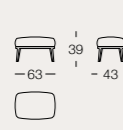

CHAIR

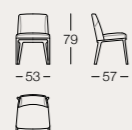

CHAIR WITH ARMRESTS



P R E C I O U S L Y H A N D C R A F T E D





MAYU

Front

Il gusto contemporaneo del duo svedese Front incontra l'abilità produttiva di Frigerio dando vita a una proposta costruita su di un delicato equilibrio di volumi. La poltrona Mayu rappresenta il punto di arrivo di un lungo processo creativo che rispetta l'idea concettuale del designer preservando comodità ed ergonomia.

The contemporary taste of the Swedish duo Front meets the manufacturing skills of Frigerio resulting in a proposal built on a delicate balance of volumes. The Mayu armchair represents the culmination of a long creative process that respects the designer's conceptual idea, while preserving comfort and ergonomics.



MAYU ARMCHAIR

Front

Poltrona con struttura in monoscocca rivestita in poliuretano espanso in densità variabile disponibile in tessuto o pelle o nella versione con schienale rivestito esternamente in pelle e internamente in tessuto.

Armchair with one-piece body covered with polyurethane foam in different densities covered in fabric or leather or in the version with backrest externally covered in leather and internally in fabric.

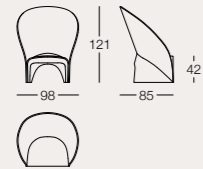

CAREFULLY
FASHIONED
DETAILS



HOME EDITION PREVIEW 2024

ADA

Ferruccio Laviani

La poltrona Ada rivisita in chiave contemporanea il design classico italiano degli anni '70 per una poltrona dalla forte personalità caratterizzata da una struttura in legno con sezioni generose e un unico volume di seduta e schienale imbottito.

The armchair Ada revisits the classic Italian design of the 1970s in a contemporary key for an armchair with a strong personality characterized by a wooden frame with generous sections and a single upholstered seat and back volume.



Dal disegno ricercato e dalla pregiata fattura, la poltrona Ada è un esercizio di stile e un omaggio alla cultura sartoriale, dove ogni piccolo dettaglio è studiato con attenzione.

With its refined design and fine workmanship, the Ada armchair is an exercise in style and a tribute to the sartorial culture, where every little detail is carefully thought out.



ADA ARMCHAIR

Ferruccio Laviani

Poltrona con struttura in legno nei colori della collezione e volume schienale e seduta rivestito in tessuto o pelle.

Armchair with wooden structure in the colours of the collection and volume seat and backrest covered in fabric or leather.

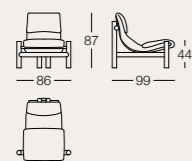

La struttura in legno dalle sezioni generose è un gioco di geometrie precise per un design intrigante e funzionale. Il volume seduta e schienale poggia sulla struttura in legno per un gioco di sovrapposizioni visive.

The wooden structure with generous sections is an interplay of precise geometry for an intriguing and functional design. The seat and back volume rests on the wooden structure for play of visual overlays.

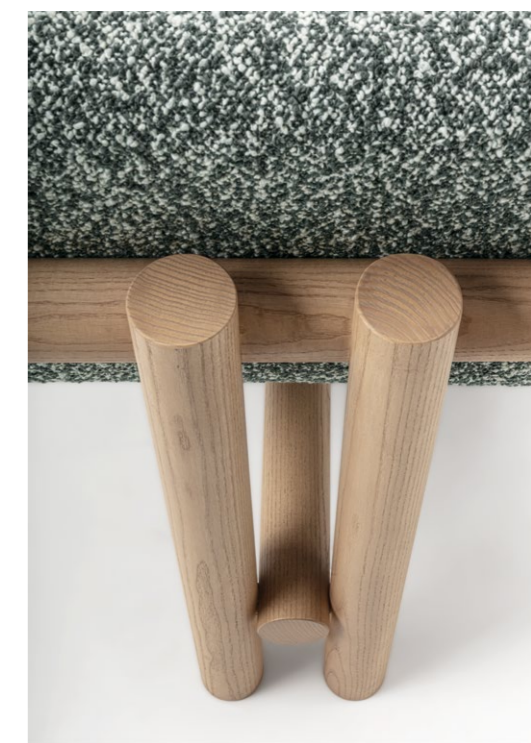



HOME EDITION PREVIEW 2024

ELLY

Oscar e Gabriele Buratti

La collezione di tavoli da pranzo Elly si caratterizza da un'ampia scelta fra top tondi, rettangolari o ovali disponibili in varie finiture come top in legno o in marmo o la versione completamente laccato lucido. Elemento caratterizzante del tavolo Elly è la struttura della gamba formata da colonne di legno fuse fra di loro in un gioco di incastri che diventa segno distintivo del progetto.

The collection of dining table Elly is characterized by a wide choice among round, rectangular or oval tops available in various finishes such as marble or wooden tops or the fully glossy lacquered version. Characteristic element of the Elly table is the leg structure formed by wooden columns fused together in a game of joints that becomes the hallmark of the design.



Finiture eleganti e sofisticazione di elementi primari, la collezione di tavoli da pranzo Elly si caratterizza da finiture dedicate che la rendono un oggetto iconico dalla forte personalità e dal carattere deciso.

Elegant finishes and sophistication of primary elements, the Elly dining table collection is characterized by dedicated finishes that make it an iconic object with a strong personality and character.



ELLY table / HUG small armchair



La versione del tavolo Elly in legno esalta la capacità artigianale dell'azienda evidenziando la texture del materiale e la particolare lavorazione della gamba che si basa su di un gioco di incastri e volumi.

The wooden version of the Elly table enhances the company's craftsmanship by highlighting the texture of the material and the special workmanship of the leg, which is based on a play of joints and volumes.



AUTHENTIC DESIGN MASTERY



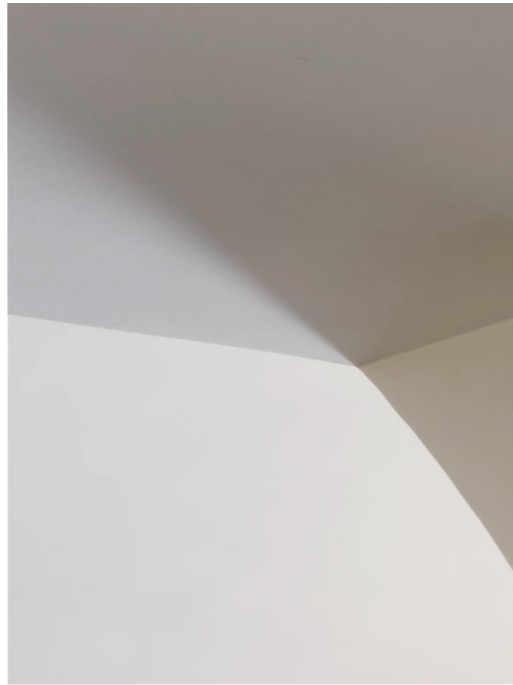

DYNAMIC SHAPES AND COLOURS



ELLY table / HUG small armchair



ELLY table / AMANDA chair & chair with armrests

ELLY TABLE

Oscar e Gabriele Buratti

Collezione di tavoli tondi, rettangolari o ovali disponibili nella versione completamente laccati o legno oppure nella versione con basamento in legno e top in marmo.

Collection of round, rectangular or oval tables available in the version fully lacquered or fully in wood or in the version with wooden base and marble top.

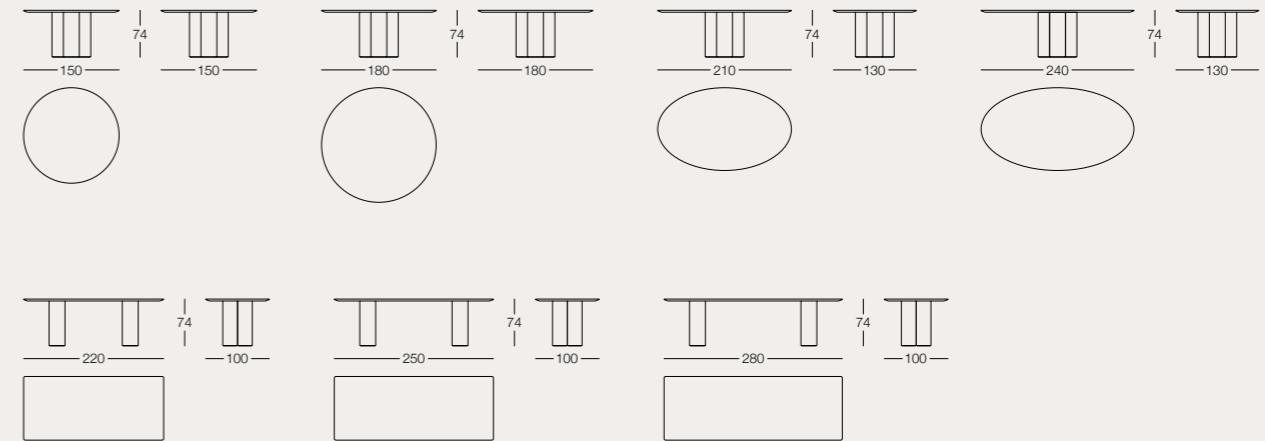



HOME EDITION

PREVIEW

2024

HUG

Oscar e Gabriele Buratti

La famiglia di seduta Hug reinterpreta in chiave contemporanea le classiche sedute per la zona dining. La sedia e la poltroncina Hug evidenziano forme accoglienti e arrotondate; il carattere avvolgente della seduta si esalta grazie alla base in metallo per un tocco moderno.

The Hug seating family reinterprets classic dining area seating in a contemporary way. The Hug chair and small armchair highlight cozy, rounded shapes; the enveloping character of the seat is enhanced by the metal base for a modern touch.





La sedia imbottita Hug si identifica nelle forme accoglienti della seduta disponibile in tessuto o pelle con base in metallo per una rivisitazione in chiave contemporanea di una seduta classica.

The Hug upholstered chair is identified in the welcoming shapes of the seat available in fabric or leather cover, with a metal base for a contemporary take on a classic seat.



BEHOLD TIMELESS FORMS



HUG | OSCAR E GABRIELE BURATTI

HUG CHAIR / SMALL ARMCHAIR / BAR STOOL

Oscar e Gabriele Buratti

Collezione di sedia, poltroncina e sgabelli, questi ultimi in due altezze, con struttura in legno e poliuretano espanso, rivestite in tessuto o pelle con gambe in metallo a sezione ovale.

Collection of chair, small armchair and bar stools, the latter available in two different heights, with wooden structure padded in polyurethane foam covered in fabric or leather with metal legs with oval section.

CHAIR

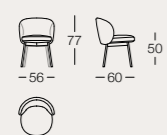

SMALL ARMCHAIR

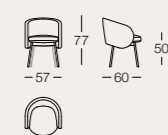

BAR STOOLS

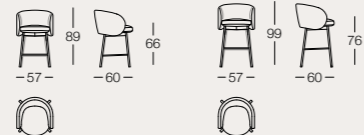

CHAIR

SMALL ARMCHAIR

BAR STOOLS



HUG small armchair / ELLY table



ELLY

Oscar e Gabriele Buratti

La famiglia del tavolo Elly si amplia con la collezione di tavolini e server che riprendono il disegno concettuale del progetto per una proposta di tavolini rettangolari o quadrati, in legno o in colore laccato lucido, con gambe decentrate e server, in metallo in colore laccato lucido, in due altezze, per un oggetto di grande contemporaneità e funzionalità.

The Elly table family is expanded with a collection of small tables and servers that echo the conceptual design of the project for a proposal of rectangular or square small tables with off-center legs in wood or lacquered glossy colour and servers, in metal in lacquered glossy colours, in two heights, for a highly contemporary and functional object.



E X P E R I E N C E C O N T E M P O R A R Y A P P E A L



ELLY small table & server / HORIZON sofa

ELLY SMALL TABLE / SERVER

Oscar e Gabriele Buratti

Collezione di tavolini rettangolari o quadrati disponibili nella versione completamente laccati o in legno. Server della stessa collezione con struttura in legno e top in metallo disponibile solo nella versione laccata.

Collection of rectangular and square small tables available fully in wood or fully in lacquered glossy colour. Server from the same collection with wooden base and metal top available only in glossy lacquered colours.

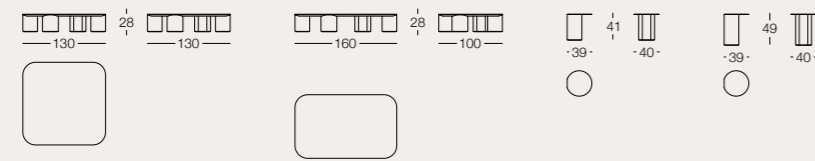

SIGNATURE
FEATURES



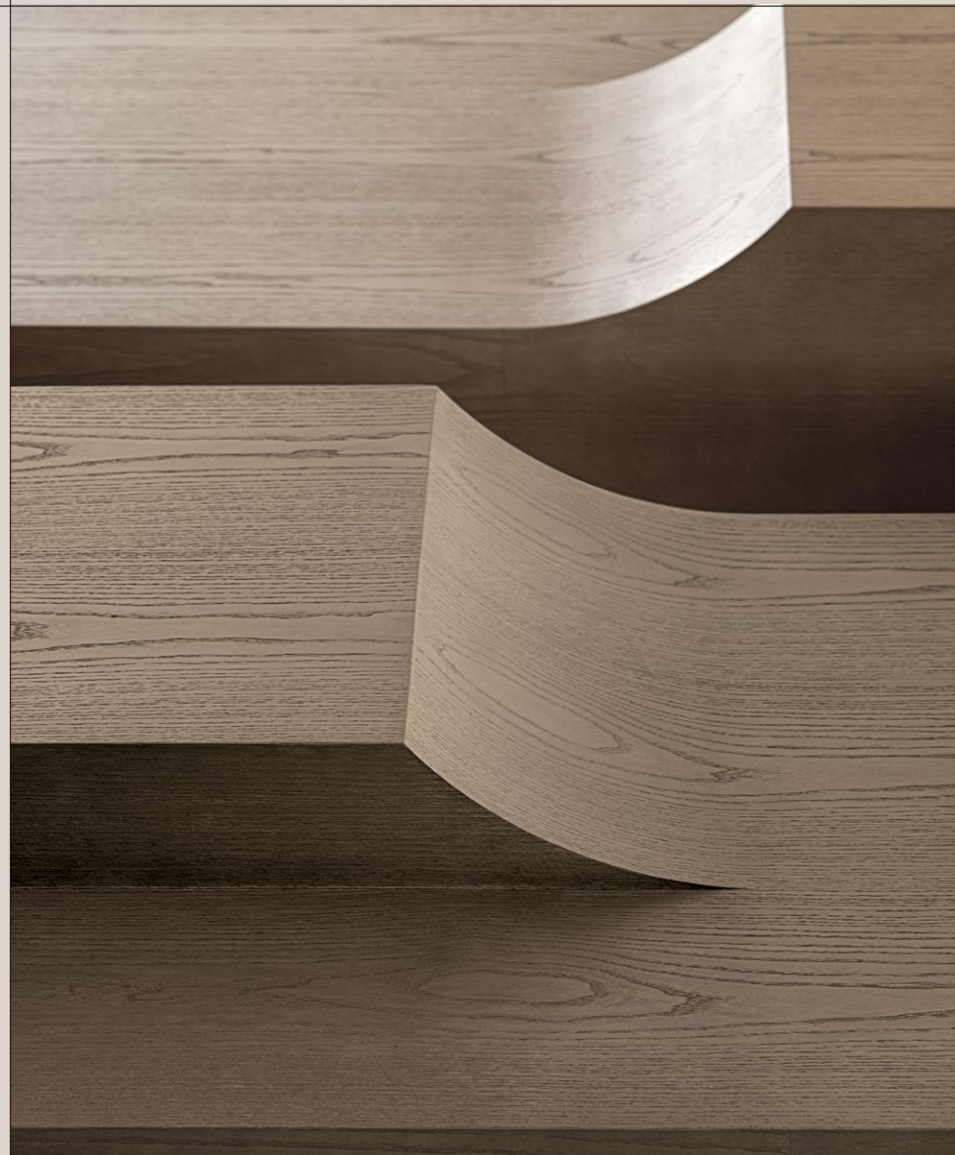

HOME EDITION PREVIEW 2024

ANDOREA

Riccardo Frigerio

Il tavolino Andorea si presenta come un elemento monolitico in legno caratterizzato da una superficie irregolare che si erge in un angolo creando una leggera curvatura che rivela l'animo dinamico del prodotto.

The Andorea small table is presented as a monolithic wooden element characterized by an irregular surface that rises at an angle, creating a slight curvature that reveals the dynamic soul of the product.



ANDOREA small table / EDDIE sofa / KEVIN small table & console



S L E E K A N D M I N I M A L I S T I C E L E G A N C E



S O P H I S T I C A T E D
S H A P E S



ANDOREA SMALL TABLE

Riccardo Frigerio

Collezione di tavolini monoblocco quadrati o rettangolari in legno, caratterizzati da una superficie irregolare con un'alzata dinamica ad uso poggialibri.

Collection of monobloc small tables square or rectangular in wood, featuring an irregular surface with a dynamic riser for use as bookrest.

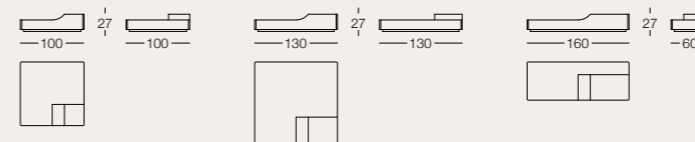



EDDIE

R&D Frigerio

Elegante e dalle proporzioni calibrate il tavolino Eddie è concepito per abbinarsi al divano della stessa famiglia, in continuità con le sue linee orizzontali, elemento configurabile come tavolino integrato nel divano o come elemento free-standing per libero posizionamento.

Elegant and with calibrated proportions, the Eddie small table is designed to match the sofa of the same family, in continuity with its horizontal lines, an element which can be configured as a small table integrated into the sofa or as a free-standing element for free positioning.



EDDIE SMALL TABLE

R&D Frigerio

Collezione di tavolini quadrati o rettangolari con vani porta oggetti, disponibili in legno o nei colori laccati della gamma. Combinabili con il divano Eddie.

Collection of square or rectangular small tables with storage space, in wood or lacquered colours of the range. It can be used with the sofa Eddie.

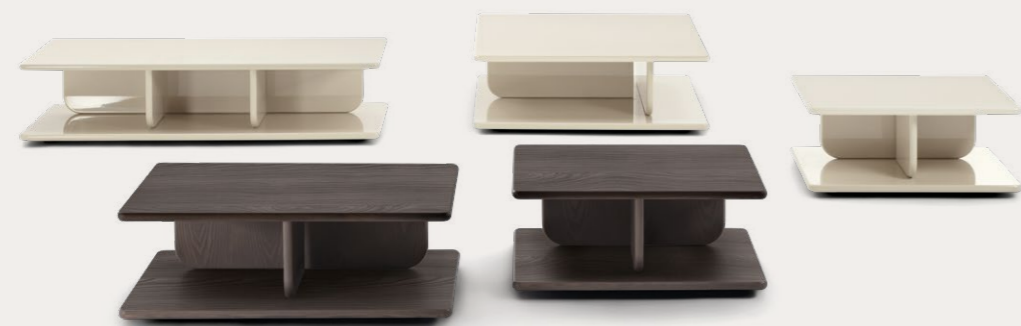
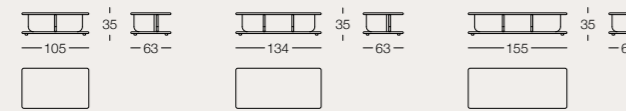
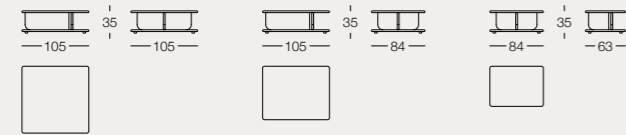

EXQUISITE
EXPERTISE





HOME EDITION PREVIEW 2024

MOCKI

Federica Biasi

Mocki è una collezione di tavolini e console caratterizzati da una struttura in legno a sezione ellittica su cui poggia un piano, disponibile in varie finiture, per un equilibrio di forme tondeggianti per un living in grado di svelare la propria personalità in dettagli raffinati.

Mocki is a collection of small tables and consoles characterized by an elliptical-section wooden frame on which a top rests, available in various finishes, for a balance of rounded shapes for a living room that can reveal its personality in refined details.





L I G H T - F I L L E D S P A C E S



MOCKI console / **AMANDA** armchair / **TAMU** mirror

MOCKI SMALL TABLE / CONSOLE

Federica Biasi

Collezione di tavolini e console con basamento in legno con sezione ellittica. Tavolino con top tondo o rettangolare con angoli smussati e console con il solo top rettangolare con angoli smussati, disponibili in differenti finiture.

Collection of small tables and console with wooden base with elliptical section. Small table with round or rectangular with rounded corners top and console with only rectangular with rounded corners top, available in different finishes.

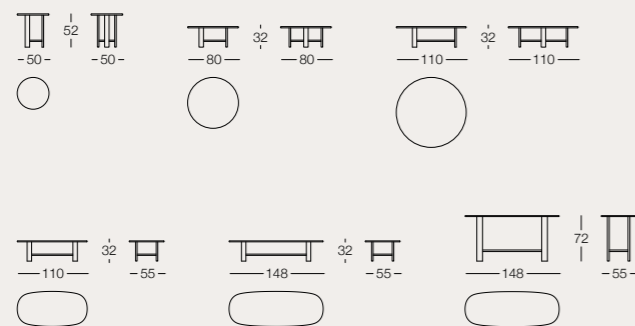

BOLD CONFIDENT
ELEMENTS

La sezione ellittica della base in legno del tavolino Mocki esalta l'artigianalità della produzione Frigerio per prodotti finemente lavorati.

The elliptical section of the wooden base of the small table Mocki enhances the craftsmanship of the Frigerio production for finely crafted products.



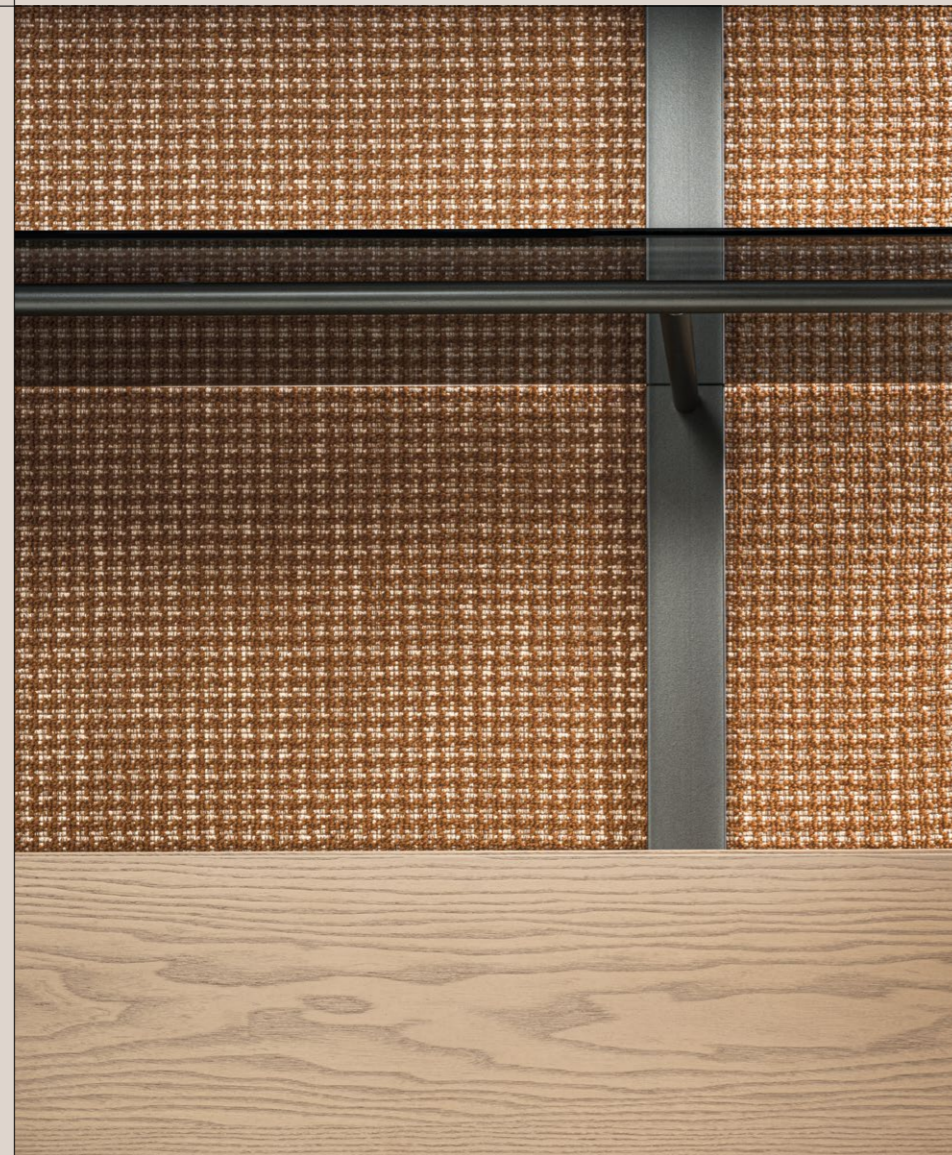

HOME EDITION PREVIEW 2024

UNIQUE

Oscar e Gabriele Buratti

La libreria Unique si caratterizza da una struttura in metallo che definisce la libreria stessa con giochi su volumi rettangolari, disponibile con o senza schienale tessile. Può essere ulteriormente arricchita con contenitori in legno con anta a ribalta.

Unique bookcase features a metal frame that defines the bookcase itself with play on rectangular volumes, available with or without a textile backrest. It can be further enhanced with wooden storage units with flap door.



Unique è una libreria con un'innata versatilità. Il telaio in metallo definisce la libreria che a sua volta incornicia oggetti del living quotidiano. Il suo rigore geometrico la rendono ideale per ogni ambiente e lo schienale tessile fornisce ulteriore personalizzazione arricchendola di colore e texture.

Unique is a bookcase with innate versatility. The metal frame defines the bookcase, which in turn frames everyday living objects. Its geometric rigor makes it ideal for any environment, and the textile backrest provides further customization by enriching it with color and texture.



UNIQUE BOOKCASE

Oscar e Gabriele Buratti

Libreria free-standing o per posizionamento a parete, con struttura in metallo e ripiani in vetro. Disponibile con contenitore in legno anta a ribalta e con o senza schienale tessile.

Free-standing bookcase or to be placed against the wall with metal structure with glass shelves. Available with wooden storage with flap door and with or without textile backrest.

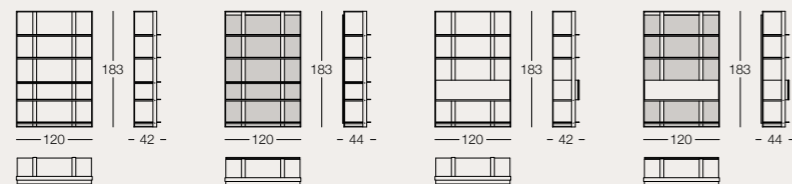

EMBRACE
FINE DESIGN

I contenitori in legno con anta a ribalta forniscono ulteriori elementi di personalizzazione per una libreria dal rigore geometrico e fortemente contemporaneo.

The wooden storage units with flap door provide additional customization elements for a geometrically rigorous and strongly contemporary bookcase.

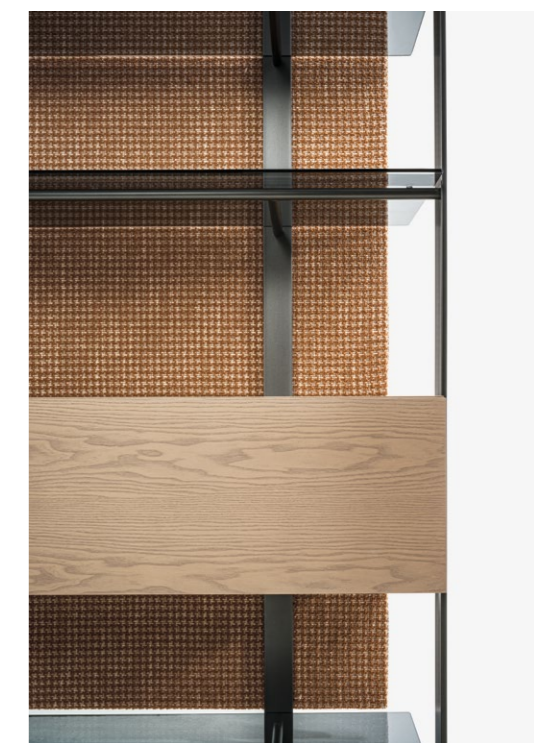



HULI

Federica Biasi

Le panche e lo sgabello Huli di Federica Biasi si caratterizzano da una struttura in legno massello e intreccio in corda per una lavorazione tradizionale dal gusto marcatamente contemporaneo, grazie ad un design leggero e ispirato a stili nordici.

Federica Biasi's Huli benches and stool feature a solid wood frame and rope weave for traditional workmanship with a distinctly contemporary taste thanks to a light design inspired by Nordic styles.



HULI BENCH / STOOL / ARMCHAIR

Federica Biasi

Collezione di poltrona, panca e sgabello con struttura in legno e intreccio in corda.

Collection of armchair, bench and stool with wooden structure and braid rope.

STOOL

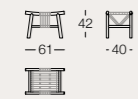

BENCH

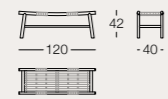

ARMCHAIR

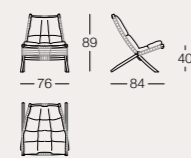
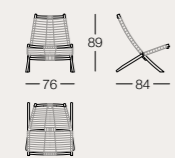

ENDURING AND
FASHIONABLE TREND



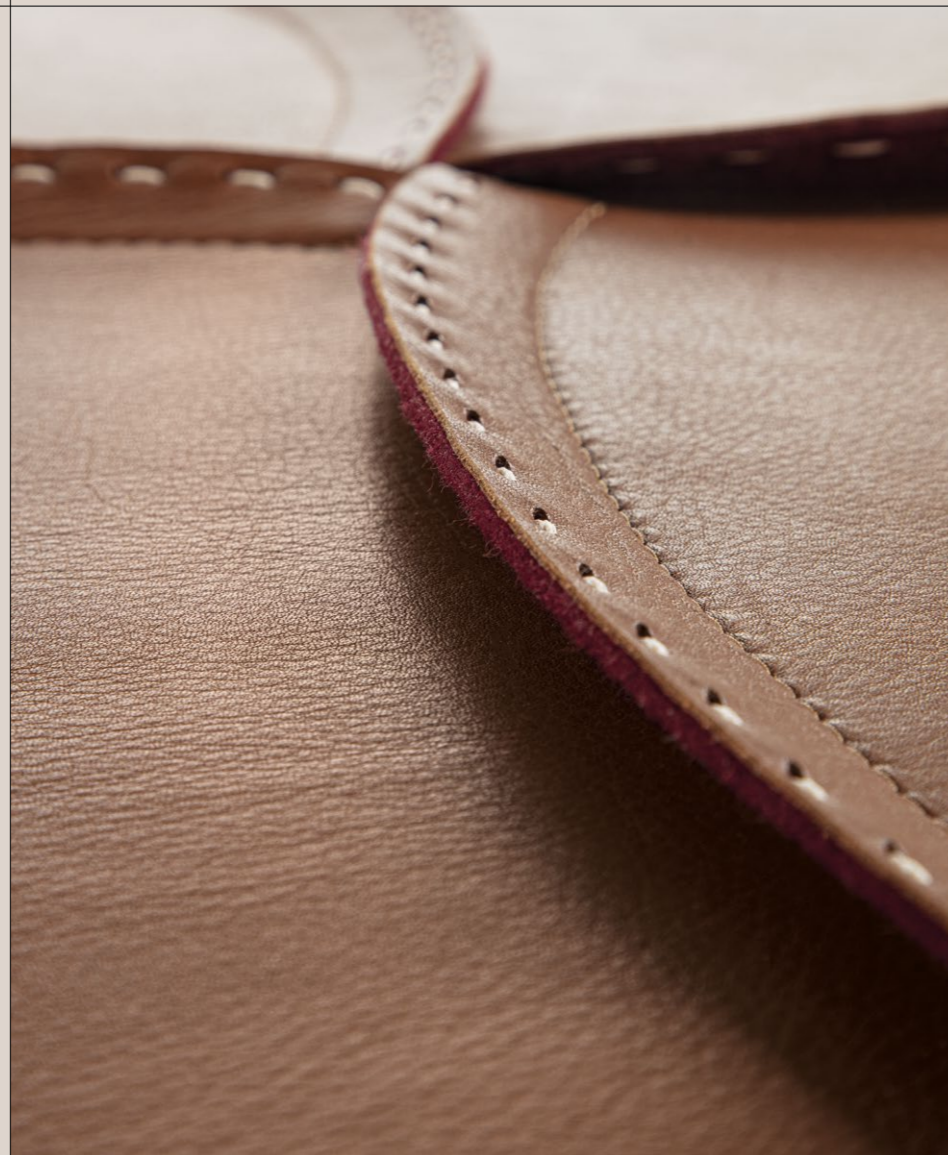

HOME EDITION PREVIEW 2024

HELIX

Front

Il pouf Helix con basamento in legno massello e forma quadrata è il risultato della maestria tecnica di Frigerio per una proposta costruita su di un delicato equilibrio di volumi grazie a lavorazioni sartoriali che si evidenziano nei dettagli del rivestimento in pelle.

The Helix pouf with solid wood base and square shape is the result of Frigerio's technical mastery for a proposal built on a delicate balance of volumes thanks to sartorial workmanship highlighted in the details of the leather cover.



C H A R M I N G F L U I D L I N E S



HELIX pouf / ADA armchair / ELLY server / UNIQUE bookcase

HELIX POUF

Front

Pouf quadrato con basamento in legno e rivestimento in pelle con cuciture decorative accoppiata a panno Beige o su richiesta panno Rosso.

Square pouf with wooden base and covered in leather with decorative stitching coupled with beige cloth or on request to red cloth.

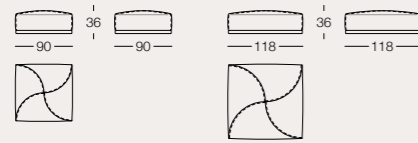

FEEL REFINED
GRACE

Il rivestimento in pelle del pouf Helix si caratterizza da cuciture decorative a vista per un dettaglio sartoriale di grande eleganza.

The leather cover for the Helix pouf features decorative stitching in contrast for a tailoring detail for great elegance.



ESSENZE WOODS



FRASSINO COLOR SABBIA
ASHWOOD SAND COLOUR



FRASSINO COLOR TABACCO
ASHWOOD TOBACCO COLOUR



FRASSINO COLOR GREIGE
ASHWOOD GREIGE COLOUR



FRASSINO COLOR LIQUIRIZIA
ASHWOOD LIQUORICE COLOUR



FRASSINO COLOR WENGE
ASHWOOD WENGE COLOUR

LACCATI LACQUERS

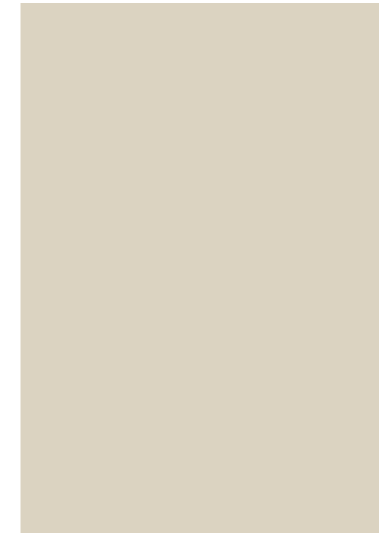

LINO



TORTORA



CIPRIA



CURRY



OLIVA



SALVIA



CORALLO



OCEANO



NERO

Le immagini sono fornite al solo scopo illustrativo e sono puramente indicative.

Pictures are merely for illustrative purposes and only indicative.

METALLI METALS



COLOR SABBIA SABLÉ
SAND SABLÉ COLOUR



COLOR GREIGE SABLÉ
GREIGE SABLÉ COLOUR

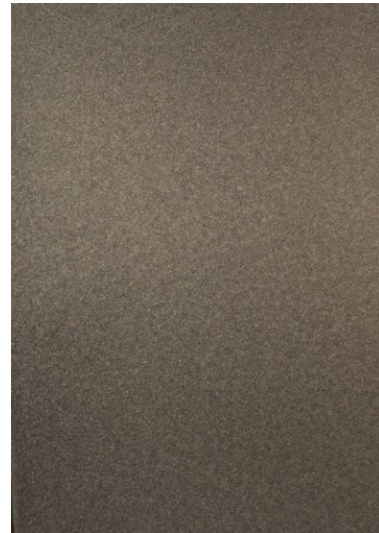

COLOR TITANIO
TITANIUM COLOUR



COLOR BRUNITO
BURNISHED COLOUR



COLOR NERO SABLÉ
BLACK SABLÉ COLOUR



COLOR ORO SATINATO
SATIN GOLD COLOUR

Le immagini sono fornite al solo scopo illustrativo e sono puramente indicative.

Pictures are merely for illustrative purposes and only indicative.

GRES EFFETTO MARMO PORCELAIN STONEWARE MARBLE EFFECT



BRIGHT ONYX LUCIDO
GLOSSY BRIGHT ONYX



GOLD ONYX LUCIDO
GLOSSY GOLD ONYX



GLAM BRONZE LUCIDO
GLOSSY GLAM BRONZE



MINERAL GREY OPACO
MATT MINERAL GREY



PIETRA GREY LUCIDO
GLOSSY PIETRA GREY



DEEP NOIR LUCIDO
GLOSSY DEEP NOIR



SAINT LAURENT LUCIDO
GLOSSY SAINT LAURENT

SCALA IMMAGINI 1:30
SCALE IMAGES 1:30

Le immagini sono fornite al solo scopo illustrativo e sono puramente indicative.

Pictures are merely for illustrative purposes and only indicative.

MARMI MARBLES



CALACATTA ORO (MR5)



DOVER WHITE (MR4)



OCEAN STORM (MR4)

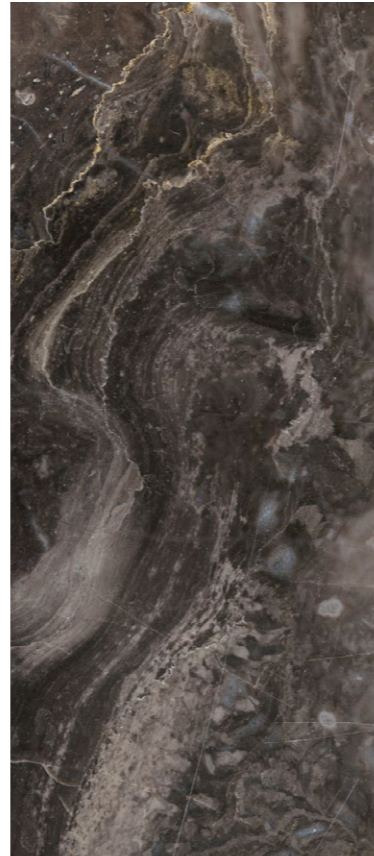

OROBICO (MR2)

MARMI MARBLES



TRAVERTINO EFFETTO NATURALE PORO APERTO / TRAVERTINO NATURAL EFFECT OPEN PORE (MR3)



TRAVERTINO PORO CHIUSO / TRAVERTINO CLOSED PORE (MR4)

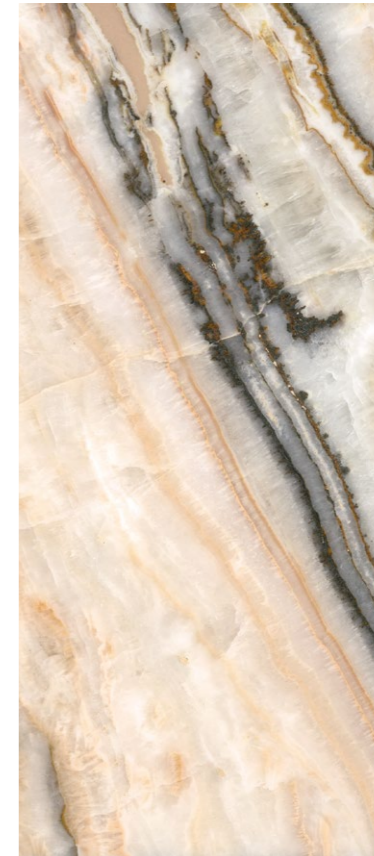

ONICE TRAVERTINO (MR3)

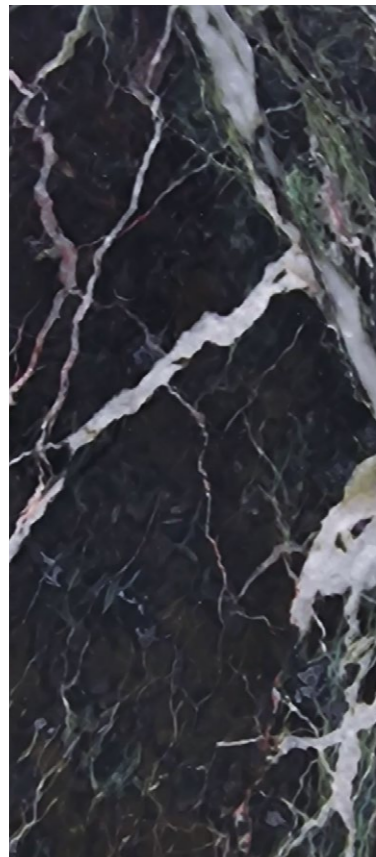

VERDE LEVANTO (MR3)



ROSSO LEVANTO (MR3)

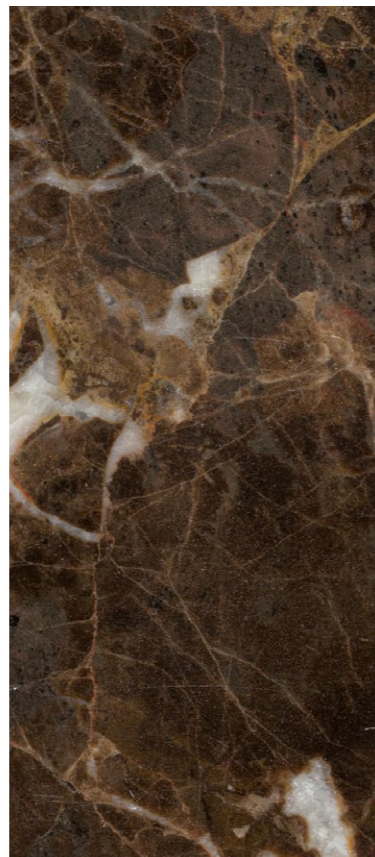

DARK EMPERADOR (MR1)

Il marmo dark emperador nella sua forma naturale presenta "buchi" che vengono chiusi durante la fase di lavorazione con resine e/o pezzi dello stesso materiale. la superficie risulta perciò irregolare a causa della presenza di micro-fessure, che sono una caratteristica del marmo .

Dark Emperador marble, in its natural form has "holes" that are closed during the working phase with resins and/or pieces of the same material. The surface results therefore irregular due to the presence of natural micro-holes, which are a characteristic of the marble.

SCALA IMMAGINI 1:1
SCALE IMAGES 1:1

Le immagini sono fornite al solo scopo illustrativo e sono puramente indicative.

Pictures are merely for illustrative purposes and only indicative.

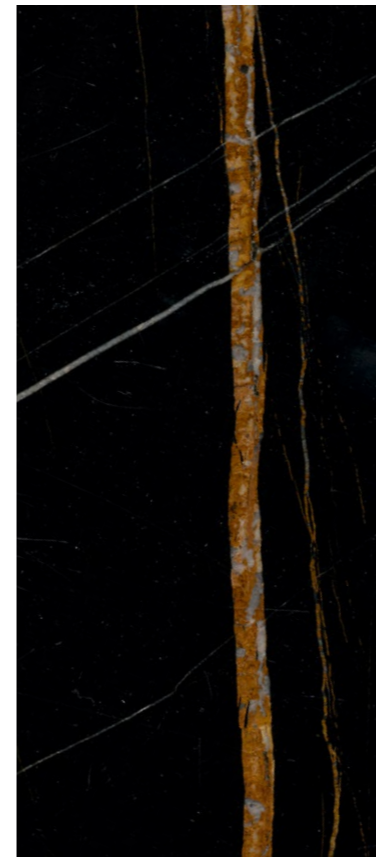

NERO SAHARA POLIESTERE LUCIDO
NERO SAHARA GLOSSY POLYESTER (MR4)

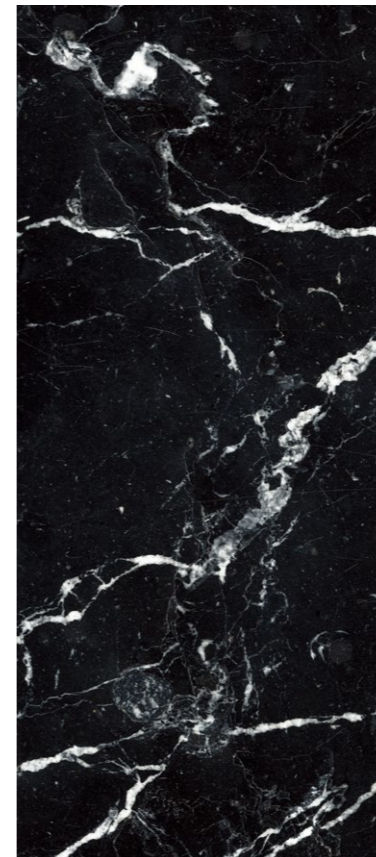

NERO MARQUINA (MR1)

SCALA IMMAGINI 1:1
SCALE IMAGES 1:1

VETRI GLASSES

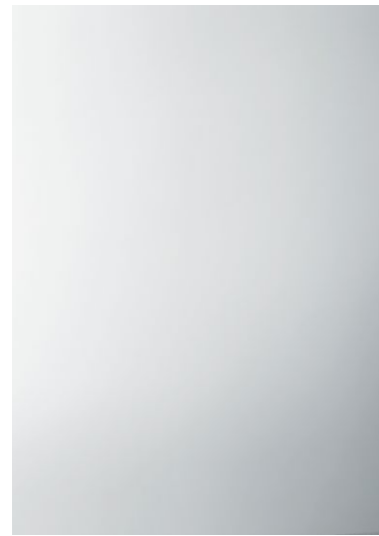

SPECCHIO LIGHT
MIRROR LIGHT



SPECCHIO BRONZO
MIRROR BRONZE

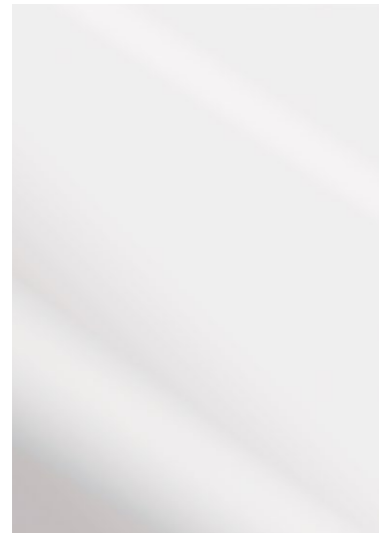

VETRO LIGHT
GLASS LIGHT

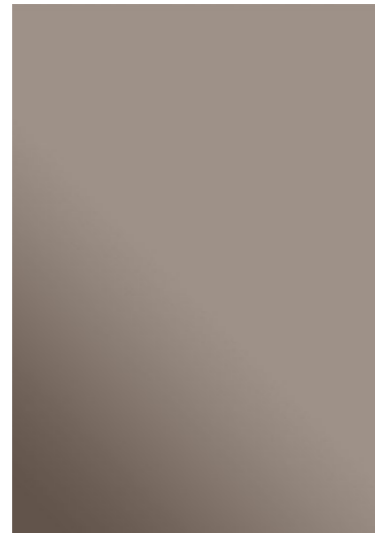

VETRO BRONZO
GLASS BRONZE



VETRO FUMÈ
GLASS FUMÈ

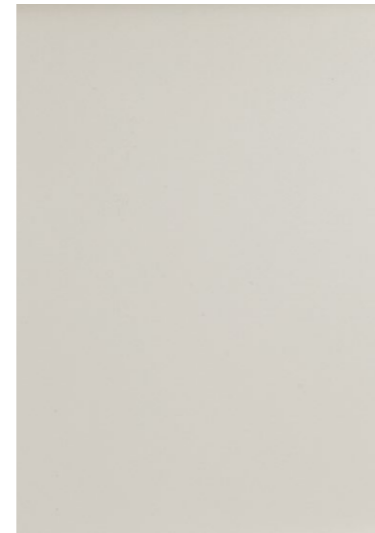

VETRO COLOR SABBIA
GLASS SAND COLOUR



VETRO COLOR TITANIO
GLASS TITANIUM COLOUR



VETRO COLOR NERO
GLASS BLACK COLOUR

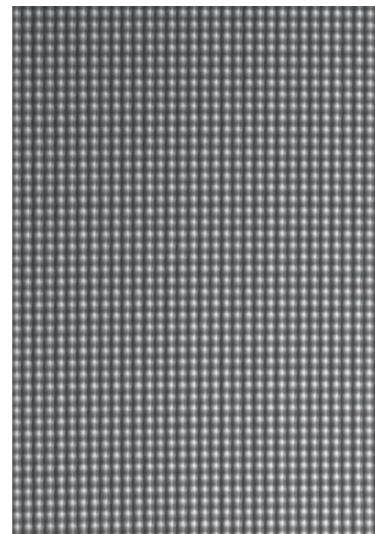

VETRO TEXTURE FUMÈ
TEXTURED GLASS FUMÈ

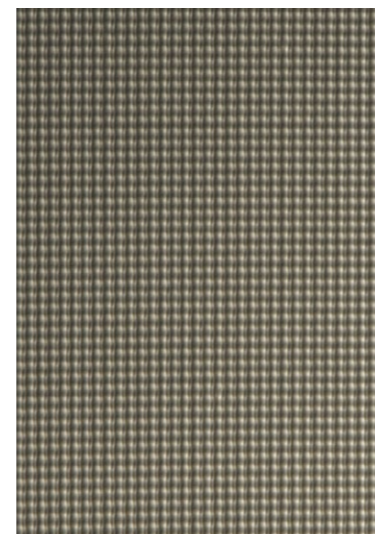

VETRO TEXTURE BRONZO
TEXTURED GLASS BRONZE

CORDE ROPES



CORDA GRIGIA
GREY ROPE



CORDA BEIGE
BEIGE ROPE

Le immagini sono fornite al solo scopo illustrativo e sono puramente indicative.

Pictures are merely for illustrative purposes and only indicative.

CUCITURE SEWING



COSTINA

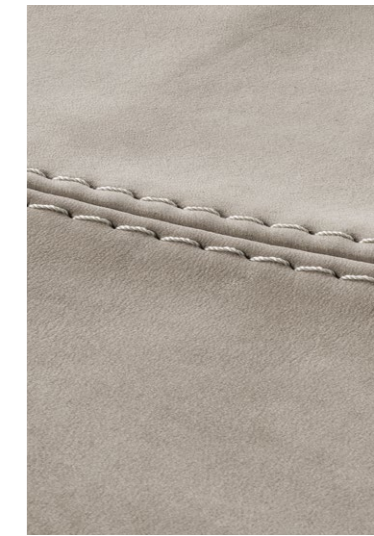

DOPPIA



PROFILO
PIPING

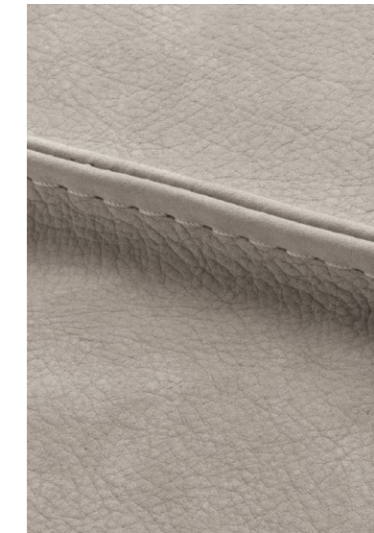

PIZZICOTTO

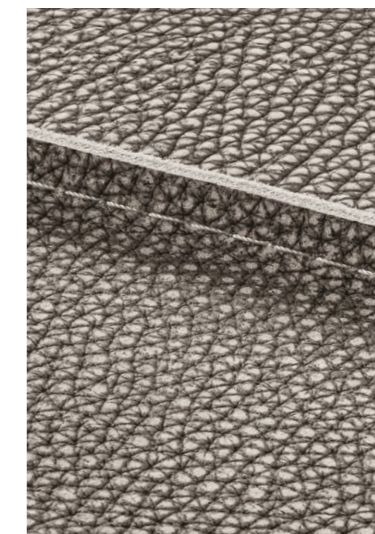

PELLE "NATURE" COSTA VIVA CON CUCITURE IN CONTRASTO
"NATURE" LEATHER COSTA VIVA WITH CONTRAST STITCHES



"CUOIO" CON CUCITURE TONO SU TONO
HIDE-LEATHER "CUOIO" WITH STITCHES TONE-ON-TONE

Art Direction:

Euro Sironi

Concept

R+W

Graphic Project:

Michela Boglietti

Project Coordination:

R&D Frigerio

Photo:

Studio Eleven

Images:

Francesca Fani Studio

Styling:

Euro Sironi

Colour Separation:

CD Cromo

Printing:

Grafiche Antiga

Frigerio

FRIGERIO POLTRONE E DIVANI SRL

Via Sant'Agata, 63

Mariano Comense CO - Italy

T. +39 031 5481225

www.frigerio.com

